













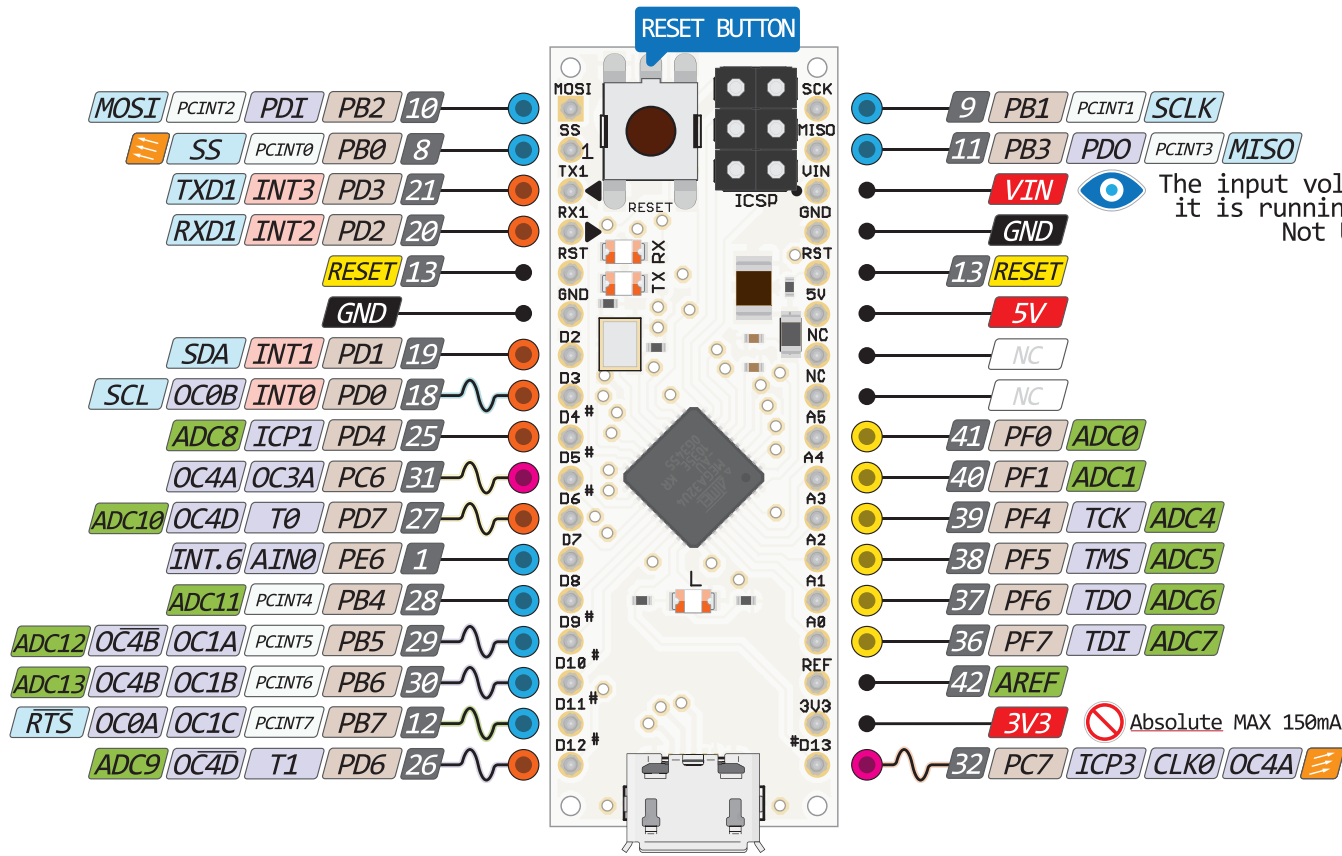
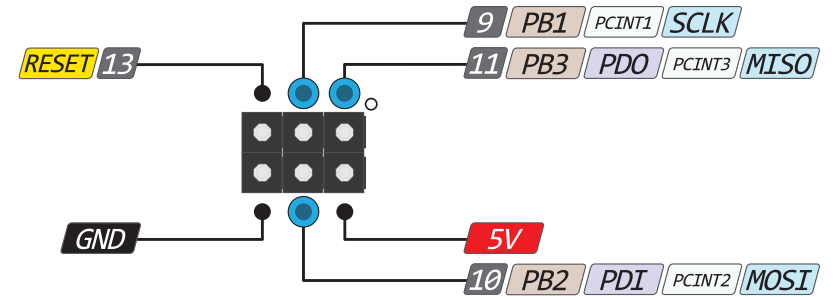



MICRO PINOUT

PWM TYPE

-  10bit
-  8/16bit
-  HS
-  16bit
-  8bit



The input voltage to the board when it is running from external power. Not USB bus power.

-  Power
-  GND
-  Serial Pin
-  Analog Pin
-  Control
-  INT
-  Physical Pin
-  Port Pin
-  Pin function
-  Interrupt Pin
-  PWM Pin
-  Port Power

The power sum for each pin's group should not exceed 100mA

 Absolute MAX per pin 20mA recommended 10mA

 Absolute MAX 200mA for entire package

